

SX4m 4 Camera B/W Simplex Multiplexer



SPX4m

Take a look at A TV's 'Simplex 4 Camera B/W Multiplexer. With multiple displays on playback and full camera sequencing in live mode, this is an affordable unit with great resolution. Available now from ATV with IR Remote Control!



IR Remote





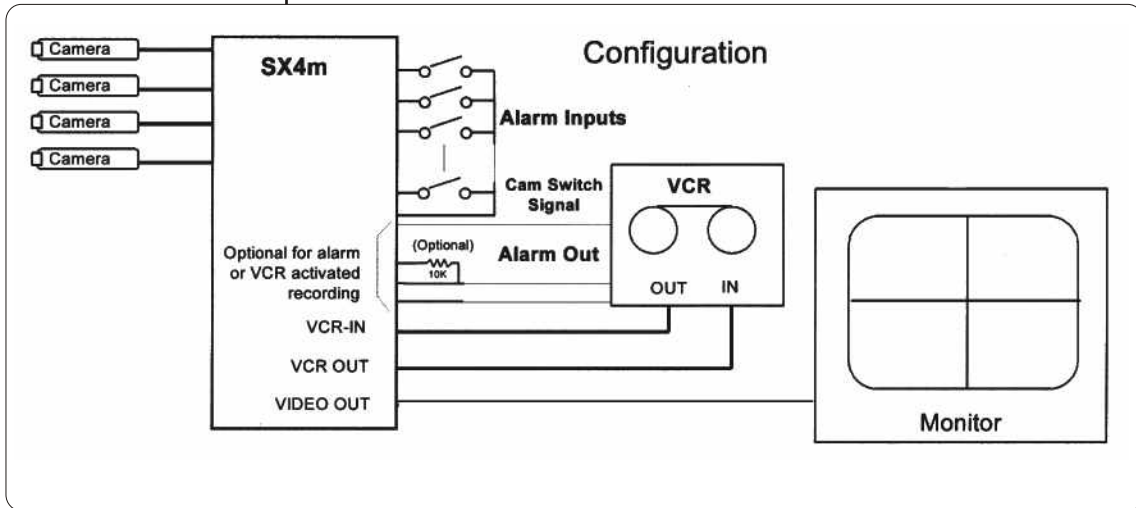

Main Features

- 4 Camera Input
- Full Looping
- Freeze / Master Enable Input
- 4 Alarm Inputs, 1 Alarm Output
- Live Roll Free Sequencing
- On Screen Menu / Advanced Menu
- Alarm Log, Alarm Scheduling
- Alarming, Custom Alarming
- Enhanced Security Lockout
- Camera Switch Input
- "Customplexing"
(priority camera multiplexing)
- Fast Multiplexing (minimum delay of 2 fields)
- Video Loss Alarm
- Custom VCR Delay Table
- VCR Bypass
- DigiLock VCR Playback Stabilization
- No Special Camera Sync Required
- AGC on all Inputs
- RS-232 Serial Port
- 8 Bit Video (256 grayscale)
- Dual Code IR Remote Control
- Alternate Languages
(English, Spanish, German, French)

SX4m 4 Camera B/W Simplex Multiplexer



Duplex Live / Playback Modes:

-  Quad (Live display is real time)
-  Movable Dual PIP
-  Full Screen
-  Movable Split Screen
-  Movable Picture in Picture (PIP)
-  Movable Squish Screen

SPECIFICATIONS:

Video Signal Format :

NTSC/EIA and PAL/CCIR Compatible
 NTSC/EIA: 525 Lines, 60 Fields per sec
 PAL/CCIR: 625 Lines, 50 Fields per sec

Resolution

512(H) x 512(V) EIA
 512(H) X 608(V) CCIR

Camera Inputs:

0.6 TO 1.2p-p 75 Ohm Termination

Camera Sync:

No special Sync Required

Monitor Output:

1.0Vp-p into 75 Ohm Termination

VCR Output:

1.0 Vp-p into 75 Ohm Termination

Electrical

Power: 12V AC @ 3 Amp

Safety: UL Listed, CSA and CE Certified

EMI: FCC Part 15, Class A, and CE Certified

Mechanical

Dimensions: H:2.3" x W:11. 5" x D:0.8"

H:6.1mm x W:288mm x D: 229mm

Weight: 2.6lbs.(1.77.kg),Power Supply:01.0lbs(0.45 kg)

Operating Temp: 32 F° - 104 F° (0 C° - 40 C°)

Accessories

ATV Part#	Description:
RCP1	Hardwire Remote
PIDM	Remote Interface
RK - SX4m	Rack Mount Kit
RM- SX4m	Remote Control
PS - SX4m	Power Supply